



Protect
your people
and your
productivity.



YOUR EMPLOYEES' SAFETY HANGS IN THE BALANCE.

The facts are alarming. According to data compiled from the Bureau of Labor Statistics, each year, hundreds of workers are killed and thousands are seriously injured by workplace falls. In addition to the tragic human toll, occupational falls constitute a considerable financial burden as well, when you factor in the significant medical and compensation costs. In response, regulatory agencies are tightening their requirements for fall protection standards, and increasing penalties and fines for noncompliance.

Are you putting your company and employees at risk?

Put safety first with Gorbel.

Since 1977, Gorbel has been committed to improving safety and productivity in every industrial environment. Workers have consistently relied on us to provide ergonomic solutions to address daily overhead lifting challenges. Today, Gorbel uses the same concepts to develop unique solutions for protecting workers at heights. By matching our rigid rail anchorage systems to your exact job requirements, we offer superior safety while allowing workers to maintain maximum efficiency by keeping them mobile. Whether the job requires protection throughout the day as part of production, cleaning, or painting activities, or just for sporadic activities, Gorbel offers systems that you and your workers will embrace.



FALL PROTECTION BY THE CODE.

WHAT OSHA REQUIRES

Under Title 29 of the Code of Federal Regulations (29 CFR), the Occupational Safety and Health Act (OSH Act) assures and enforces safe and healthful working conditions for general industry, construction, and maritime trades. Employers have the duty of providing their workers with a place of employment free from recognized safety and health hazards.

OSHA enforces regulation 1926, Subpart M, for construction and regulation 1910, Subparts D and F, for general industry, which specify when fall protection is required. These regulations must be followed under penalty of law. To avoid potential fines and citations, be sure to carefully assess your workplace environment and potential fall hazards.

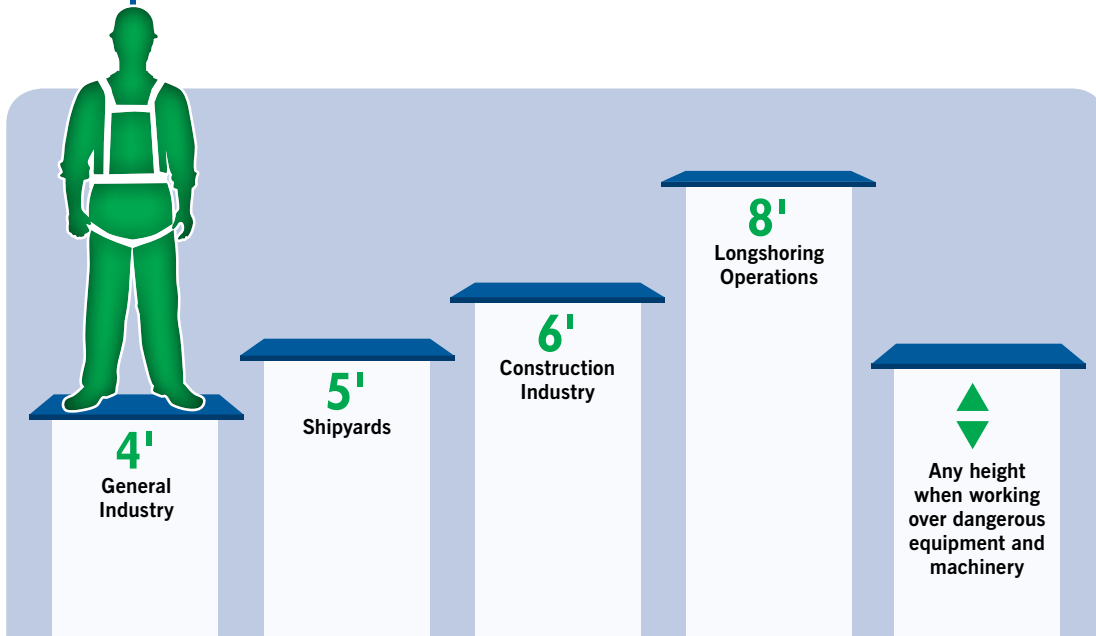

OSHA regulations 1926 and 1910 mandate fall protection for employees working at or above these heights.

WHAT ANSI RECOMMENDS

In addition to federal regulations, there are voluntary consensus standards regarding fall protection set forth by the American National Standards Institute (ANSI) and Canadian Standards Association (CSA). ANSI and CSA specify product performance and testing criteria for personal fall arrest equipment. While these standards are voluntary, they should be adhered to, as they are often adopted by OSHA and other regulatory agencies, and provide important guidelines for fall protection and fall arrest product safety. Visit ansi.org for more information.



ELIMINATE THE GUESSWORK WITH TETHER TRACK.®

A fall arrest system is an active means of protecting workers from falls in elevated environments. When using fall arrest systems, one of the most critical considerations is choosing a safe anchor point that offers total protection when used with full body harnesses and self-retracting lifelines (SRL).

With Tether Track, guesswork is removed from the process, as your workers are assured a fully engineered anchorage system developed for their specific job. After all, keeping them productive and safe is the essence of our system. The complete system, consisting of full-body harnesses, retractable lifelines, and Tether Track as the essential anchor, provides a high degree of mobility and freedom to perform tasks while stopping falls in the shortest distance possible.

WHY CHOOSE TETHER TRACK?

Gorbel's Tether Track Rigid Rail Fall Arrest Systems are a reliable, cost-effective way to reduce the risk of injury in elevated work environments. Systems are available for both single and multiple workers. Unlike some traditional horizontal lifeline systems, Tether Track enables workers to effortlessly pass one another without disconnecting from the system—minimizing the risk of a fall during the reattachment process and maximizing overall user acceptance.

The building block for Gorbel's rigid anchor system is our enclosed track design, which is engineered for easy movement. The cold-rolled steel track keeps dirt and dust from settling on the rolling surface, allowing for smoother, more consistent ease of movement than an I-beam with no need for cleaning or maintenance of the track.

The track also features a running flange with a 2-degree taper to keep the trolley centered. That allows the trolley and attached lanyard to easily follow the worker, rather than forcing them to pull free a trolley that has become stuck.

Our rigid rail anchor systems are designed by qualified engineers to meet or exceed the OSHA 1926 Subpart M Construction standard, the 1910.66 App. C General Industry Standard, and ANSI Z359 Fall Protection Code using a maximum off-vertical loading of 30 degrees. This strict design criteria means that our track supports the full impact of falls vertically and also at a 30-degree angle. That's important for applications where the risk is to fall off the side of an object rather than straight down.



2-degree taper keeps the trolley centered

WHY RIGID RAIL FALL ARREST IS BEST.

LESS FALL CLEARANCE REQUIRED

Wire rope systems require additional fall clearance due to the initial sag of the wire. By eliminating both the initial and dynamic sag distance, the Gorbel Tether Track Rigid Rail Fall Arrest System stops the fall in a much shorter distance, making it the best option for low-headroom applications. With a shorter overall fall distance than wire rope, less clearance is required from the anchor point to the floor below.

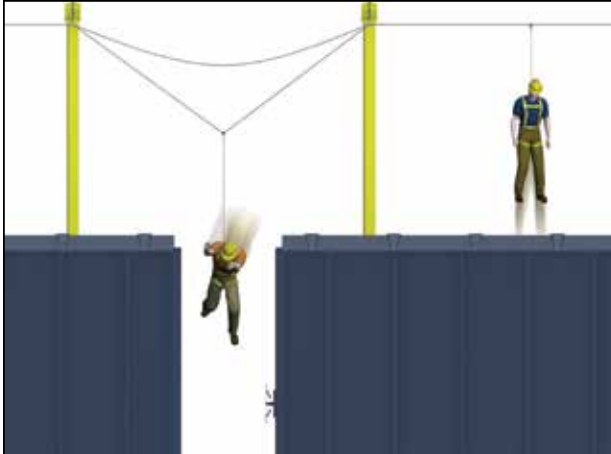

Wire rope systems can create hazardous situations due to the dynamic sag of the wire after a fall.

REDUCED RISK OF SECONDARY FALL INJURIES

Injuries occurring after the fall, such as swinging into obstacles, are minimized with an anchorage system that stays firm and minimizes total fall distance. When a worker falls on a wire rope system, the wire's sag will make the trolley slide to the center of the nearest two supports, creating a risk for the fallen worker to collide with nearby obstacles as the trolley centers itself.

LONGER DISTANCES BETWEEN SUPPORTS

A rigid anchor system allows you to cover greater lengths between supports without sag. This reduces both material and installation costs for your system, and also makes installation easier with fewer restrictions for where supports will be located.

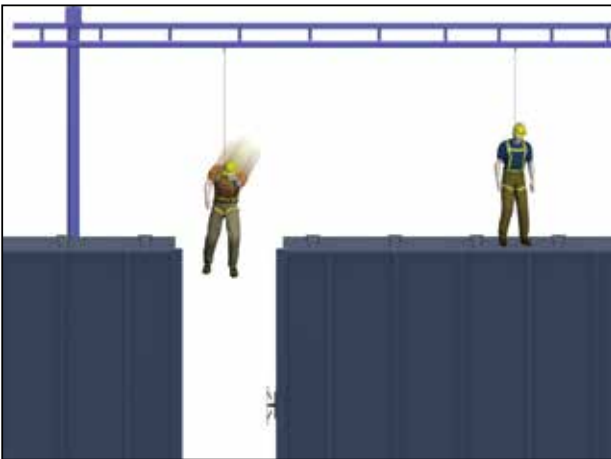

Tether Track Rigid Rail Fall Arrest Systems provide shorter free-fall distances, reduced risk of secondary fall injuries, such as swinging into obstacles, and no negative impact on a second worker in the event of a fall.

SAFER FOR MULTIPLE WORKERS

When a worker harnessed to a wire rope system falls, any slack on the wire is eliminated. The result could be a sudden pull on the rope that can have a jarring effect on other workers using the same system, putting them at risk. The risk is accentuated when more than one worker is attached to a wire rope system between the same support centers. If one worker falls, the chances are great that all other workers attached in the same support range will also experience a fall. Rigid rail systems provide uninterrupted protection for additional workers on the same system without putting them in harm's way. Thus, each worker is responsible for his/her own actions and will not be severely impacted should a co-worker fall.

LESS FORCES ON BUILDING STRUCTURES

Due to the nature of wire rope systems, it is often very difficult to find a suitable anchor point without significantly reinforcing existing structures. This is primarily due to forces being exerted in both horizontal and vertical directions on these types of systems. With rigid rail systems, the forces are much more controlled and the systems are often installed without structural modifications.



COMPONENTS OF A FALL ARREST SYSTEM

ANCHORAGE

A secure point of attachment for lifelines, lanyards or deceleration devices; commonly referred to as a tie-off point.

CONNECTING DEVICE

A device used to link the body support component of the system to the anchorage connector, such as a shock-absorbing lanyard or self-retracting lanyard (SRL).

BODY HARNESS

Provides a connection point on the worker to distribute the forces evenly across the body in the event of a fall.

GORBEL FALL ARREST SYSTEMS: DESIGNED WITH YOUR NEEDS IN MIND.

At Gorbel, we understand that you face unique challenges when protecting your workers at heights. To address these challenges, Tether Track is available in configurations suitable for virtually every indoor and outdoor application. From maintenance of heavy plant machinery to unloading flatbed trailers, there is a Tether Track system to meet your needs. All systems described here are designed for components that are rated for the industry standard 900 pounds maximum arresting force (MAF). Options are available to address unique requirements, such as long spans, outdoor environments, work area obstructions, and related items. Since each system has unique characteristics, problem-solving is addressed at various levels, starting with onsite consultations with a knowledgeable dealer or representative. From there, our team of customer service representatives and fall protection product specialists are on hand to assist in providing the exact system to meet your needs.

Gorbel's engineering team provides custom solutions for a wide range of activities. Dedicated, qualified engineers can provide various options to address applications where "off-the-shelf" devices may be insufficient. Individual welders are certified in accordance with Structural Welding Code AWS D1.1, to ensure that the product you receive is of a consistent, premium quality.

WHY GORBEL'S TETHER TRACK SYSTEM SHOULD BE YOUR FALL PROTECTION CHOICE.

WORKER PROTECTION

It is up to the user to choose an adequate anchor point while on the job. Using Tether Track takes the guesswork out of the decision. Tether Track is designed and built for fall arrest, plain and simple. With Tether Track in place, workers are no longer inclined to choose an anchor point that is designed for something other than personal protection.

AVOID SWING FALLS

Swing falls may occur when the anchorage point is located in an area that is not directly above the worker. With fixed anchorage points, workers may need to move a considerable distance from the anchor. Even if all parts of the system work in unison to prevent a free fall, the worker will swing back to the anchor point. If an obstacle exists between the worker and the anchor point, the worker may impact this obstruction with considerable force. Because Tether Track is designed to move with the worker and stay directly overhead, chances of a swing fall injury occurring are greatly reduced.

REDUCE FALL DISTANCE

When the decision of choosing an anchorage point is left entirely to the worker, low points that are easily accessible may seem to be the best option. Many times, these points may be at waist or feet level, thus adding to the overall fall distance that could occur. If a lower level is located in close proximity, the worker could strike this level as part of the fall. Tether Track is designed for maximum protection, as the anchor point is kept well overhead, thus reducing overall fall distance.

COSTS OF A FALL

When examining all of the potential costs associated with a fall, Tether Track represents an effective "insurance policy," offering tremendous value. The direct costs of a fall can be seen in escalating medical insurance premiums and workers' compensation costs. An OSHA investigation could occur, resulting in fines. But, there are indirect costs, such as lost-time charges and the time spent to hire and/or train a replacement worker. Some costs are difficult to measure, but there is no guarantee that an employee who suffers a fall will ever be as productive as before, when they return to work. It is only human nature to worry about a fall after experiencing such an event, rather than focusing on the job at hand, if they return to work at all.

PEACE OF MIND

Utilizing Tether Track as part of a complete fall arrest system provides an optimal solution to protect your workers. With so many companies touting strict policies regarding safety, Tether Track fits perfectly as part of a safety-conscious culture. Providing maximum protection for workers at heights with quality equipment designed specifically for the task is reassuring to all levels of the organization.

TETHER TRACK® SYSTEMS



Monorail Systems

FREE STANDING

Engineered for areas that require long spans and an independent structure for support, this system provides a single path of fall protection in a permanent manner. Used widely in areas where floor space is readily available, Free Standing Monorail Systems are ideal for the transportation and agricultural markets. Numerous configurations are available, including cantilever designs offering economical options and long span capabilities. They are extensively used for outdoor applications and can be treated with special finishes to withstand the elements.

Free standing cantilevered monorails are available in heights up to 26 feet to effectively protect workers maintaining, inspecting, or loading/unloading railcars, tankers, or flatbed trucks.



CEILING MOUNTED

When floor space is at a premium, ceiling mounted monorails can provide unparalleled fall protection while maintaining an open floor plan for material handling, production, or related activities. Ceiling mounted monorails use existing support steel for overall anchorage strength, and are ideal for production facilities and warehouses with tall ceilings since column support is not needed. Even if the facility has standard ceiling heights, the compact, low-profile design of ceiling mounted monorails provides full protection without head-room concerns.

A fall arrest solution
that conquers a
distributor's curved
conveyor concerns.

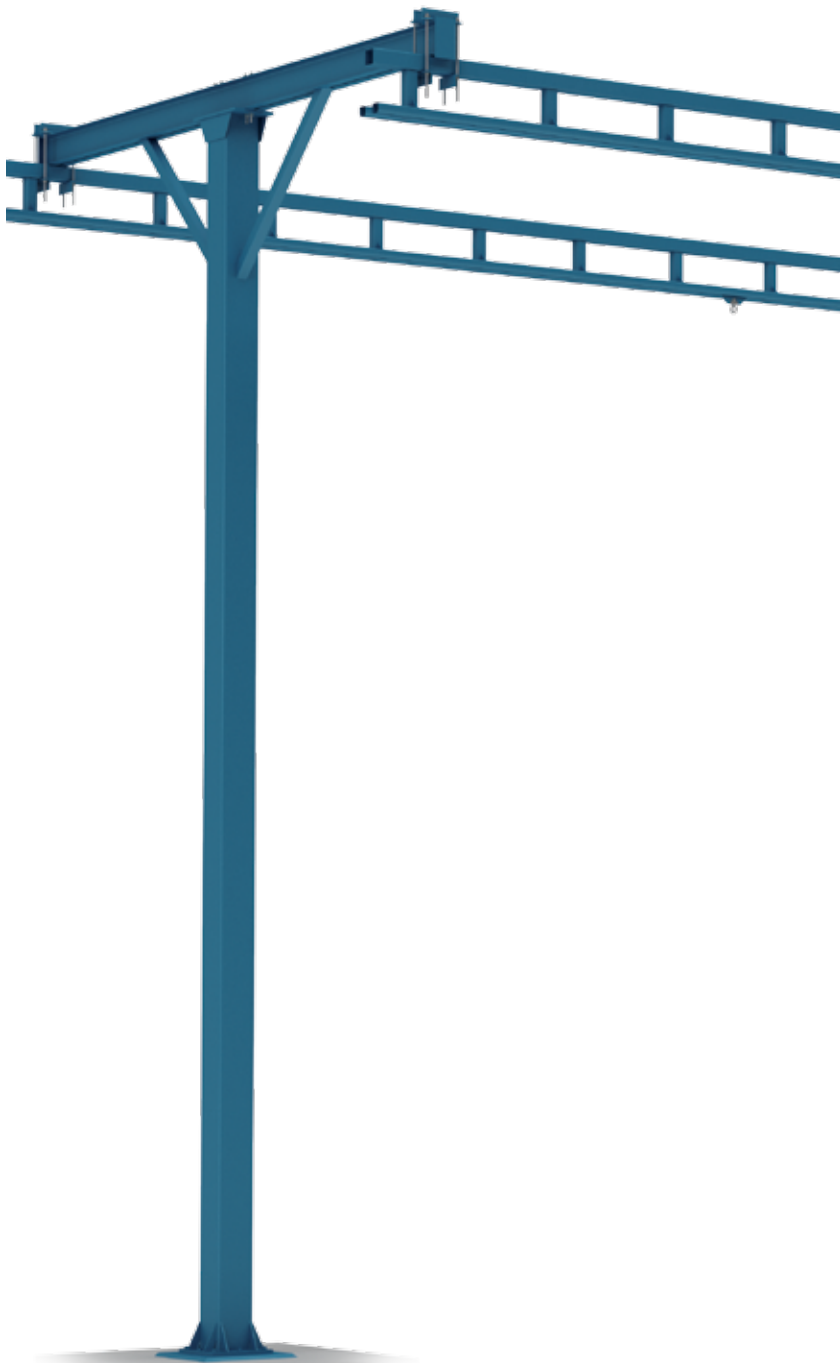

AUTO PARTS DISTRIBUTION

Safety and Productivity at Every Turn

A major auto parts distributor was concerned about the safety of employees who were required to climb out onto their extensive conveyor system to perform maintenance and repairs. In exploring their fall protection options, they were concerned that their curved conveyors—in particular, a floor-to-ceiling spiral conveyor—would make it impossible to provide adequate fall arrest protection.

The solution was to install four plain-track, straight monorail systems in one building. Three of the systems were 282' long, and the other was 102' long, and covered the straight conveyors in that building. In the second building, a 340' straight monorail was installed to cover the straight conveyor lines feeding into multiple curved monorail sections. Now, when workers perform maintenance on the conveyors, they simply attach the lanyard to their harness and have fall protection every step of the way.

TETHER TRACK® SYSTEMS

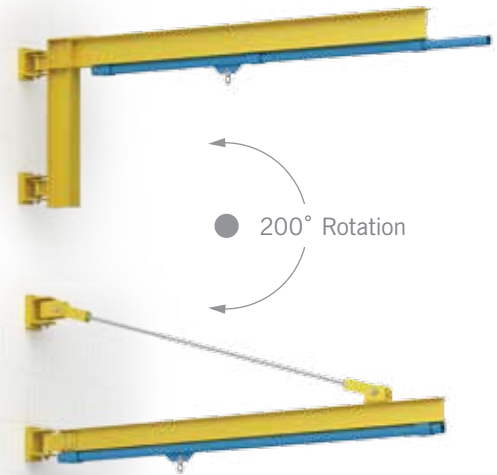

Swing Arm Systems

When space is an issue or ceilings are inaccessible, swing arm systems can provide flexible solutions in industries ranging from food distillation to coal processing. The Tether Track Swing Arm Fall Arrest System provides circular or semicircular fall protection within a limited footprint. Used extensively in areas where both overhead cranes and fall protection systems share the same space, swing arm systems may be mounted to an existing wall column or to the floor in a free standing configuration. Since swing arm systems may be easily moved out of the way when not in use, they are ideal for applications where infrequent fall protection is necessary.

- Available in Wall Cantilever or Wall Bracket Configurations based on headroom constraints
- Turnkey drive packages available
- Standard spans 8' to 30'; custom spans are also available
- Friction brake is included for multiple-worker systems; also an option for other systems



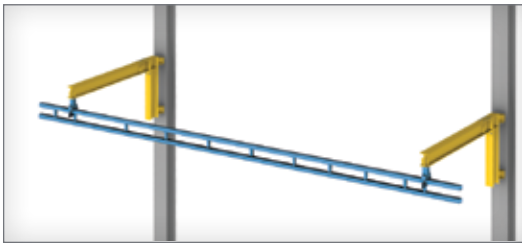

Fully-deployed system

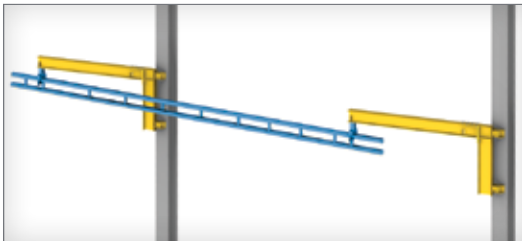

Folds away when not in use

Fold Away Systems

Gorbel's Fold Away Systems provide safety when you need it, and space when the system is not in use. Similar to the swing arm systems, Tether Track Fold Away Systems supply convenient fall arrest when extended without sacrificing productivity.

Ideal for areas such as railroad maintenance facilities or where large food processors must be regularly maintained, these systems may be easily moved from the work environment when fall protection is not essential. By deploying only when needed, fold away systems allow complete access to overhead cranes in order to keep production at high levels.

- Unlimited lengths with up to 50' between supports
- Motorized rotation available
- Trussed track to accommodate single or multiple workers
- Available in free standing or wall/column mounted designs

TETHER TRACK® SYSTEMS



Bridge Systems

Like monorail systems, bridge systems are available in either free standing or ceiling mounted configurations.

CEILING MOUNTED SYSTEMS use the structure for support, as the rail is mounted either perpendicular or parallel to the ceiling beams. Should overhead obstacles be present, drop rod hangers with sway bracing can be supplied so that the system avoids these obstructions.

FREE STANDING SYSTEMS may be preferred whenever floor space is readily available to install column supports, when changes in work practices are anticipated, and when a building structure isn't available. The flexibility of free standing systems allows them to be easily modified and moved should processes or fall protection needs change.

Multiple bridges can be supplied for both ceiling mounted and free standing systems, thus allowing multiple workers to utilize the system simultaneously.

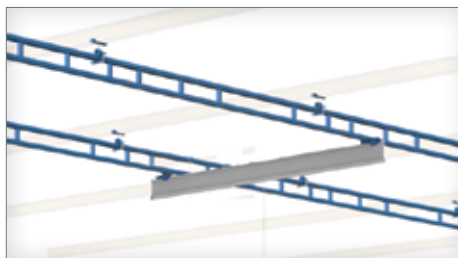

Ceiling Mounted

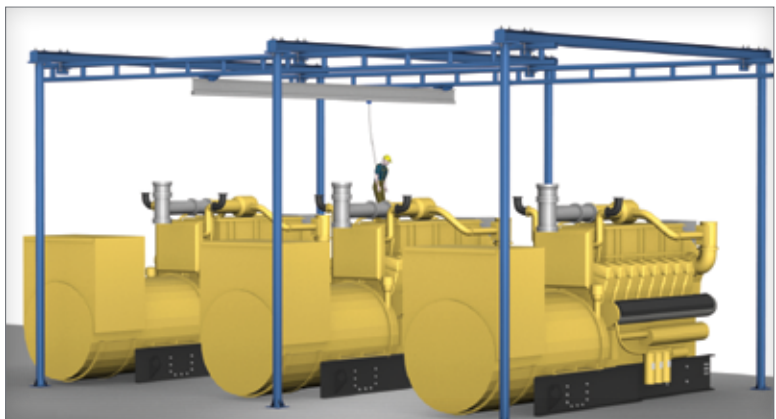

Free Standing



Portable Gantry Systems

The Tether Track portable fall arrest gantry is ideal for applications where a permanent solution is not possible. It allows for single or multiple users to complete their required tasks, and can then be moved out of the way when not needed. The square tubing uprights, knee braces, and channel base allow for stable movement, while the Tether Track trolley rolls smoothly on an enclosed track flush mounted beneath the beam.

- Available at fixed heights up to 20 foot hook height, and spans up to 20 feet
- Adjustable heights available as an option
- Multiple areas can be serviced with a single, portable unit
- Different caster options available dependent on the environment
- Casters include cam breaks and swivel locks to keep gantry from moving



BUS MAINTENANCE

Tether Track Brings Peace of Mind to Transportation Authority

Recently, a transportation authority began replacing old buses with more fuel-efficient hybrid vehicles to decrease fuel costs and emissions. When these new buses need maintenance, workers must climb to the bus roofs to cut power from the electric battery packs. The solution was installing four identical ceiling mounted Gorbel Tether Track anchor systems with Miller self-retracting lanyards with 20 feet of line. The Tether Track style chosen featured a 39-foot-long dual-trussed monorail, which fully covers the length of the buses and allows for multiple workers to be on the roof of the bus and safely pass one another.

TETHER TRACK® SYSTEMS



2 Bay System: Our single-post system requires a single foundation, saving you money and space.

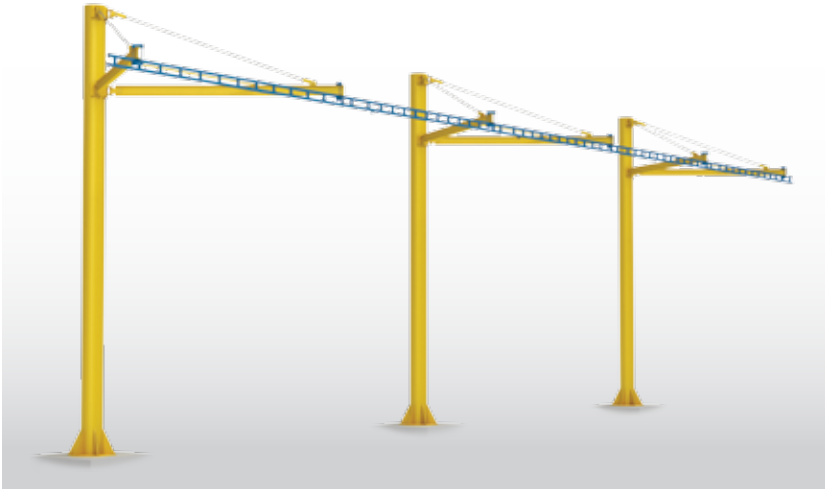

The linked single-pole configuration allows spanning greater distances between supports.



Single Pole Systems

When numerous obstacles exist in the work space and standard multiple-column systems are not practical, single pole systems provide a convenient alternative. Used regularly in tank car servicing or heavy-duty truck securing and tarping areas, single pole systems require only a single foundation. Standard span lengths from 10' to 53' mean the system can be designed to meet the requirements of most loading/unloading and maintenance facilities.

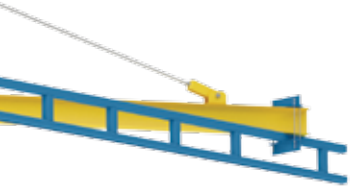

Custom Options

In addition to our standard systems, Tether Track can be customized to meet your exact needs. Whether your requirements are driven by individuals, or are a result of multi-departmental specifications, our certified engineers and welders will create a Tether Track system that's right for you.



COMPONENTS OF A TETHER TRACK® SYSTEM.

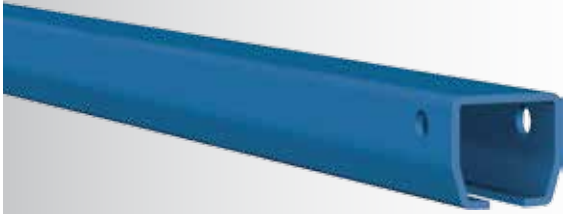

Tracks

PLAIN TRACK

Plain enclosed steel track provides smooth motion with the benefit of offering the most headroom of any track style.

Track Series	MAXIMUM SUPPORT DISTANCES ¹		MAXIMUM CANTILEVER ²	
	1 Worker	2 Workers	1 Worker	2 Workers
F500	12 feet	7 feet	2.5 feet	1.5 feet
F1000	18 feet	12 feet	4 feet	2.5 feet

TRUSSED TRACK

Single trussed track allows for the longest possible spans between supports, reducing hardware and installation costs.

Track Series	MAXIMUM SUPPORT DISTANCES ¹		MAXIMUM CANTILEVER ²	
	1 Worker	2 Workers	1 Worker	2 Workers
F500S	20 feet	16 feet	4.5 feet	3.5 feet
F500SL	25 feet	18 feet	5.5 feet	4.5 feet
F500SLX	30 feet	22 feet	6.5 feet	5.5 feet

DUAL TRUSSED TRACK

The dual track enables one worker to pass by another on a monorail system without unsafely disconnecting.

Track Series	MAXIMUM SUPPORT DISTANCES ¹	MAXIMUM CANTILEVER ²
F500SLD	50 feet	5.5 feet

¹ For longer support distances or custom applications, contact Gorbel Inside Sales.

² Cantilever is the overhang distance from the system's last support.

Intended for indoor use. For outdoor applications, contact Gorbel Inside Sales.

Tether Trolleys™

- Provide fluid movement and stability
- Features innovative DURACOMP 4® wheels
- Swivel eye allows for free movement beneath trolley
- 3-axle design prevents binding inside the track when side loaded

MONORAIL TROLLEY

- Specifically designed for fall arrest applications
- Smooth running
- DURACOMP 4 wheels
- 2-degree taper on all wheels
- 3-wheeled design for 30-degree offset loads
- Swivel prevents twisting of the lanyard

CURVED MONORAIL TROLLEY

- More compact, 3-wheel design with shorter wheelhouse
- Short wheel base allows trolley to navigate smoothly through curves without binding

BRIDGE

- The bridge always follows the worker and is directly above them

DURACOMP 4® is a material that delivers unmatched durability and consistent long-term performance.

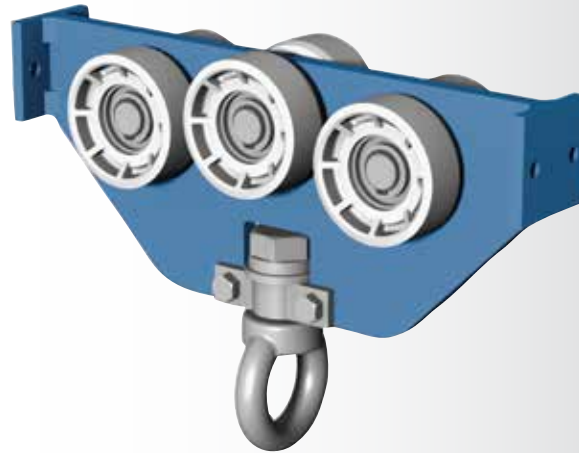

Wheels

- Made of DURACOMP 4
- Reduced wear
- Quieter
- Variable temperature operation (from 5 to 250 degrees F)
- Sealed lubricated bearing with lifetime guarantee reduces maintenance costs
- Tapered wheel matches track profile, keeping trolley and end trucks centered
- Changeable light press fit wheels can be easily replaced in the field
- Safety—wheels will wear before the track
- 10-year warranty on wheels

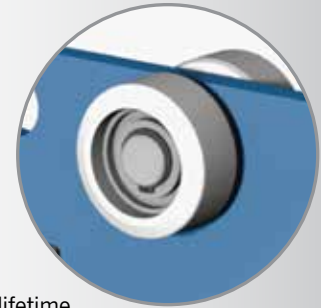

Special Finishes

Whether in a food processing, pharmaceutical, or harsh outdoor environment, all Tether Track Rigid Rail Fall Arrest Systems are available with special finishes to meet the needs of the job.

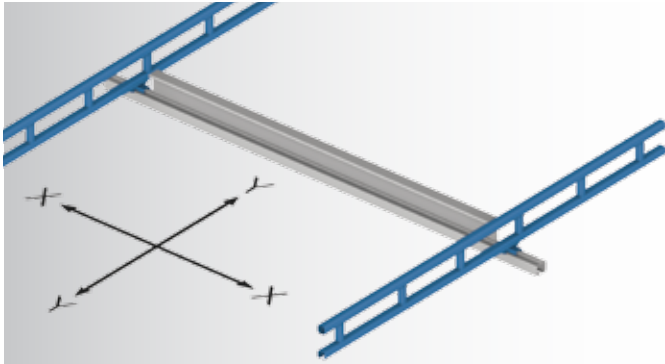

Aluminum Bridges

The bridge system allows for two axes of motion. This gives the worker complete mobility along the x and y axes, while keeping the fall protection anchor point directly over the worker's head, reducing the risk of swing fall injuries. Multiple bridges are the best solution for supporting multiple workers.

- Up to 45% lighter than steel bridges
- Allows bridge to follow workers' movement at all times, limiting fall distance
- Suited for different types of environments
- 18' maximum standard bridge length
- Longer bridges available upon request
- Easier for the worker to move around

Sway Bracing

- Required on ceiling mounted systems, offered as option in other configurations

Tractor Drives

- Available on bridge systems
- Ideal for more than one user per bridge

Hangers and Supports



Standard assembly
(upper/lower hanger
bracket)



Flush mount

Also:

- Plain support brackets
- Plain and trussed track:
20" standard rod drop



Sloped
ceiling

Drive Package

- Consists of a reducer, clutch, motor, junction box, electrical enclosure, panel, and conduit
- Four different drive packages available, based on span, bracket center distance, and fitting size

Friction Brake

- Optional friction brake stops the rotation of the swing arm or fold away
- Infinitely variable disc brake can be locked out at any degree interval
- Allows for multiple users to work safely on the same track

The Drive Package and Friction Brake apply ONLY to swing arms and fold away systems.

TETHER TRACK® FAQs

What maximum arresting force (MAF) are your systems designed to?

A Most systems are designed to 900-lb. MAF standard. However, they can be custom designed to 1800-lb. MAF.

Can a Tether Track system support multiple people at one time?

A One of the benefits of a Tether Track system is that it can be designed to support multiple workers. There is no real limit to the number of people; the system would be designed based on your need/application.

At what intervals does the system have to be supported?

A Each system is designed for the specific application and the number of people on the system. We have customized support centers up to 50'.

Can the systems be used outdoors?

A Yes. However, to prevent oxidation, special finishes are recommended.

Can they be made from stainless steel?

A Yes. Many of the systems can be made from stainless steel. This is recommended if you expect the system to be used in a caustic or wet environment.

How often should the system be inspected?

A A Tether Track system should be examined by the user before every use, but must be inspected and documented annually by a "competent person."*

What are the recertification requirements?

A Following a fall, a system must be inspected before being placed back into service. A complete guide on the inspection requirements is included in our installation and maintenance manual.

Can Tether Track be installed inside a building with a sloped roof?

A Yes. Special sloped ceiling hangers are available to address this common application.

Can you curve the track?

A Curves are available. 90-degree curves are the maximum angle we provide as standard.

Is there a rotation brake for a fold away or swing arm system?

A Yes. A swing arm or fold away system can be purchased with a rotation brake—a type of disc brake designed to be reusable in the event of a fall.

Can you motorize the rotation on a swing arm or fold away system?

A Yes. A motorization package can be purchased for both swing arm and fold away systems.

Can these systems be customized outside of what is listed on the literature?

A Yes. Each system is custom designed and engineered for the specific application.

*As defined by OSHA 29 CFR Part 1910

Fall Protection Resources

The organizations below can supply complete details regarding fall protection requirements. Much of the information is provided free of charge, while some documents are available only for purchase:

OSHA

Occupational Safety and Health Administration
 osha.gov
 800-321-6742

ANSI

American National Standards Institute
 ansi.org
 212-642-4980

CSA Group

csagroup.org
 800-463-6727

To access Gorbel's FALL PROTECTION TOOLKIT and FALL PROTECTION PLANNING RESOURCE, visit www.gorbel.com/righttrack.



FOR MORE INFORMATION

Your authorized Gorbel® dealer can give you more information on what makes Gorbel's Ergonomic Work Station Cranes and other material-handling products "A Class Above."

BRIDGE CRANES



WORK STATION BRIDGE CRANES AND MONORAILS



CLEVELAND TRAMRAIL®

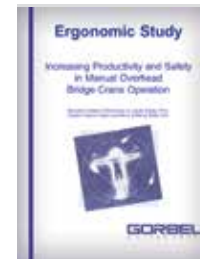

ERGONOMIC STUDY

ERGONOMIC LIFTING



G-FORCE®/EASY ARM®

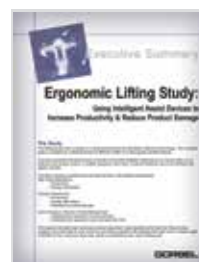

ERGONOMIC LIFTING STUDY

JIB CRANES



JIB CRANES

GORBEL®
 A C L A S S A B O V E

www.gorbel.com

GORBEL
 600 Fishers Run
 PO Box 593
 Fishers, NY 14453 USA

T 800.821.0086
 T 585.924.6262
 F 585.924.6273
 E info@gorbel.com